

直方体と立方体2

(展開図)

年 組 名前 ()

下の図の続きをかいて、展開図を完成させましょう。

(ますの1辺の長さは1cm)

(1)

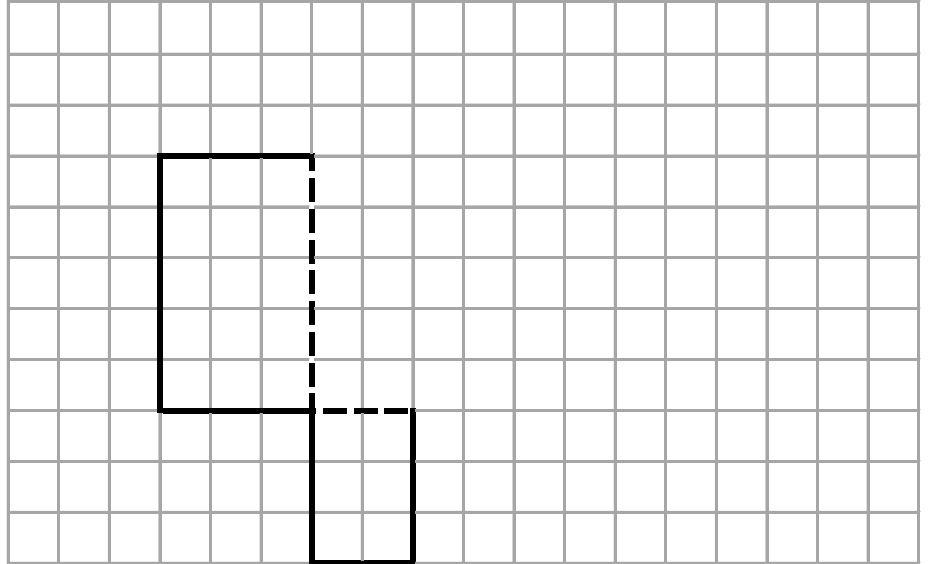
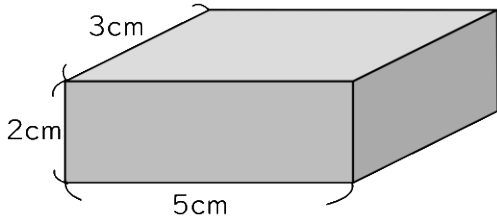

(2)

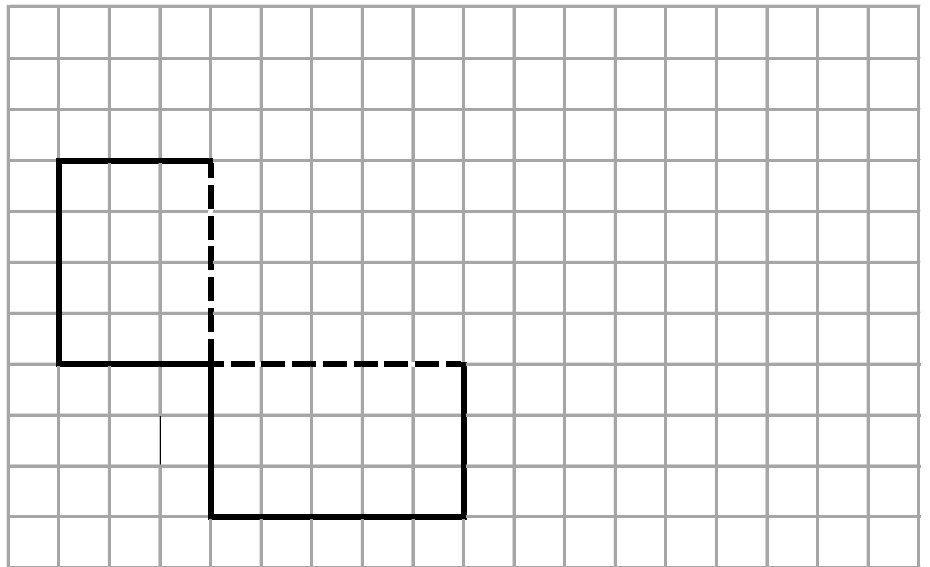
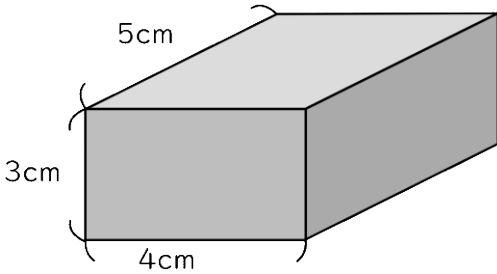

(3)

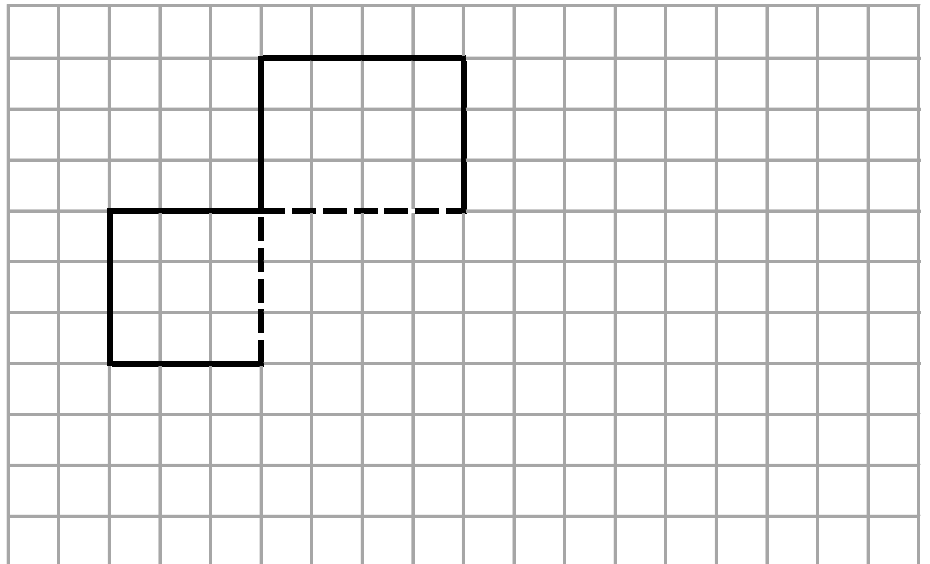
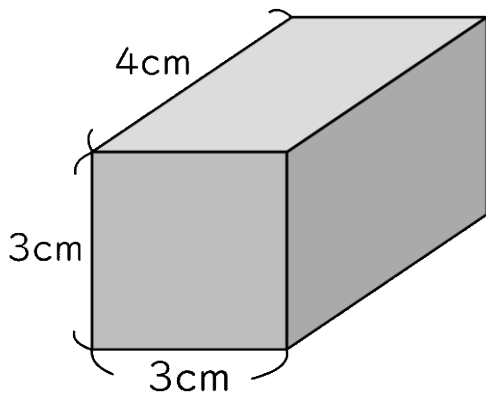

直方体と立方体2

(展開図)

年 組 名前 ()

下の図の続きをかいて、展開図を完成させましょう。

(ますの1辺の長さは1cm)

(1)

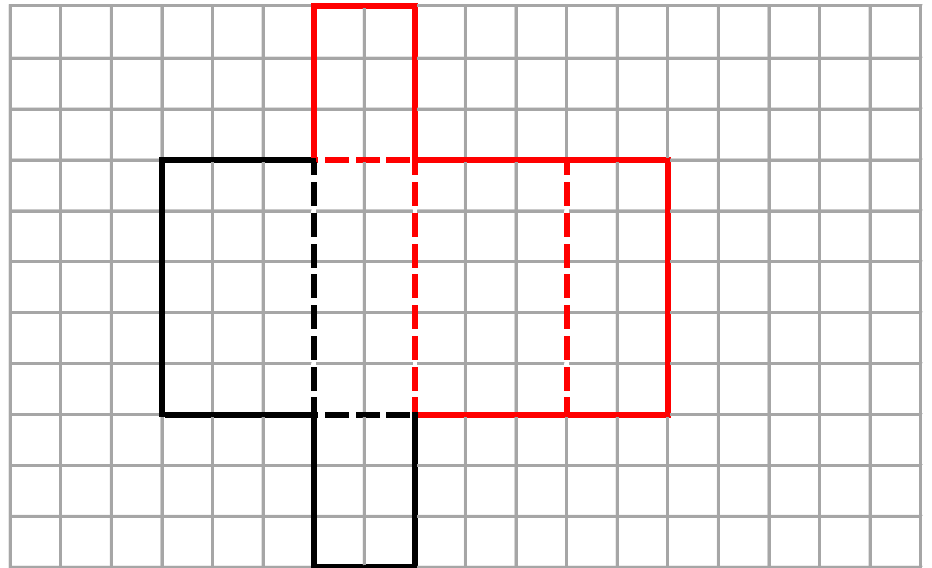
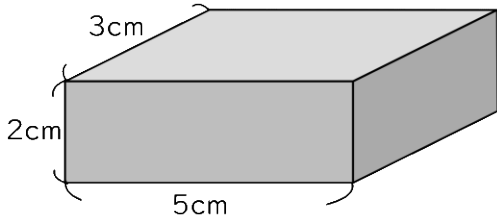

(2)

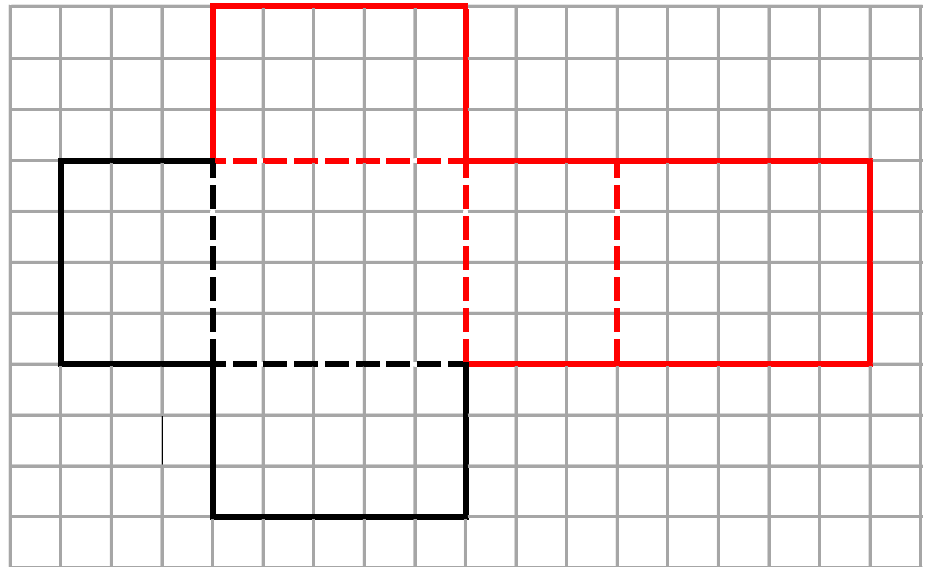
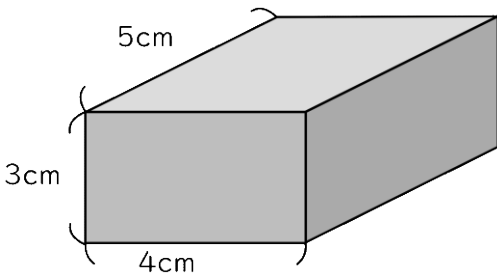

(3)

